

# Install SIM

**A** If your Airgain Partner has preinstalled the SIM, skip to step 1 (Connect Antennas to the Router).

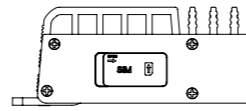

**B** Remove the **SIM card** cover by pressing a thumbnail or flathead screwdriver in the gap between the metal and plastic. You should now see the edge of the black **SIM tray**.

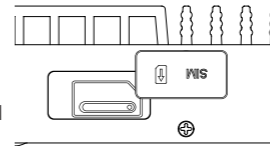

**C** Remove the **SIM tray** with the included SIM Ejector Tool by inserting the tool into the hole on the **SIM tray**; the tray should pop partway out. Remove the SIM tray completely.

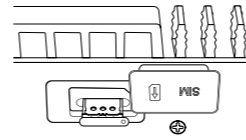

**D** Insert your activated **SIM** into the tray. **Note:** Flip the tray around so that the tray is notched so the card can be inserted the correct way. Press the cover back into place.

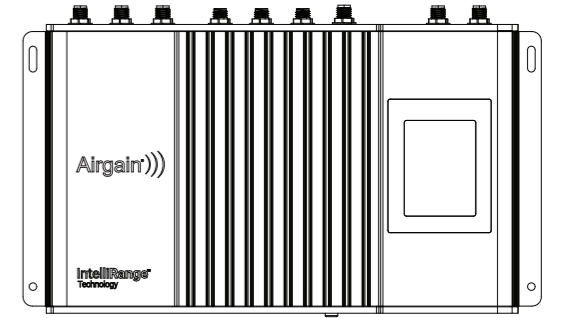
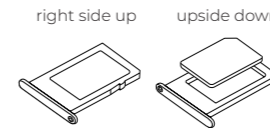

Copyright © 2026 All Rights Reserved. The Airgain logos are registered trademarks of Airgain, Inc. All other trademarks or registered trademarks listed belong to their respective owners. Rev. 30Apr26



For more information scan the QR code or contact Customer Support at: [connectivity.support@airgain.com](mailto:connectivity.support@airgain.com)



For product information scan the QR code or refer to the MegaFi 2 documentation at [www.airgain.com/products/megafi-2-hpue](http://www.airgain.com/products/megafi-2-hpue)

## Included In the Box



DC power cord

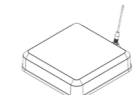

Roof antenna



Ethernet cable



SIM ejector tool

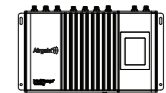

Router

# 1

## Connect Mount Antenna Leads to the Router

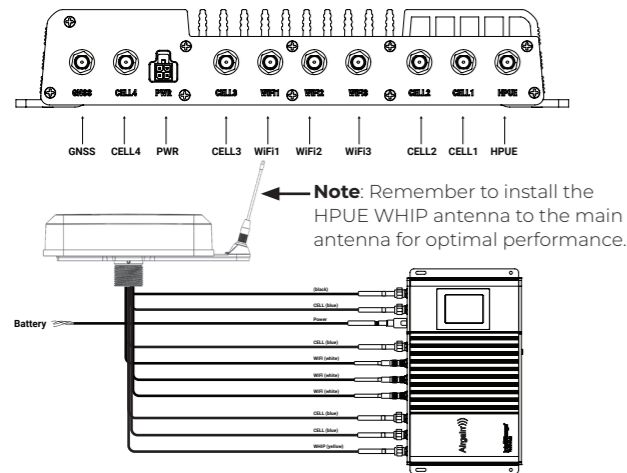

Connect the antenna leads to the MegaFi 2 as follows: **CELL (blue)** leads to the **CELL** ports, **WIFI (white)** leads to the **WiFi** ports, **(black)** lead to the **GNSS** port, **WHIP (yellow)** lead to the **HPUE** port. Please note, **WiFi** ports have a pin, while the **HPUE** and **CELL** ports do not. **WiFi** antenna leads do not have a pin, while Cellular antenna leads do have a pin. Connecting a Cellular antenna lead with a pin to a **WiFi** port with a pin will damage one or the other or both. If location data is desired, make sure the **GPS** antenna has an unobstructed view of the sky.

**Note:** SMA connectors have a maximum torque of 3-5 inch lbs. Over-torquing may damage the connectors and void warranty. It is also recommended to add stress relief to the end of the antenna cables right before connecting them to the SMA connectors on the MegaFi 2 device.

# 2

## Connect Power to the Router

1. Connect the **DC power cable** to your **DC power source**.  
**Note:** Red = + Positive, Black = - Negative, Orange = Ignition Sense Blue = GPIO or Sleep Sense.
2. Connect the DC power cable to the port labeled **PWR** on the device.

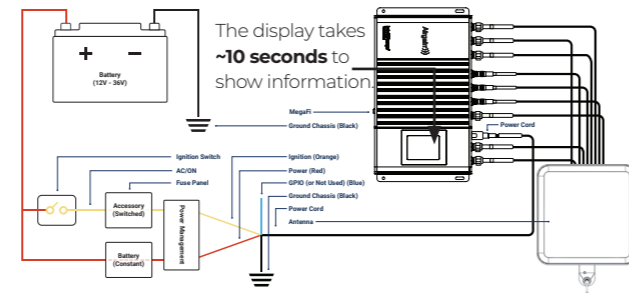

After connecting the antennas and power, the LCD display will illuminate with device status and information. By default, the display screen will rotate between 3 pages every 15 seconds. The page will begin to indicate cellular connection signal strength, connection to the network, status for High-Power mode (**HPUE**), **Internet**, **GNSS** connection, and **WiFi**. This information will be shown on all 3 pages.

Please refer to the MegaFi 2 User Guide for more details on what other information is displayed on all 3 pages. The bootup process will take a few minutes before a successful connection is indicated by an illuminated **Internet** icon. If the router does not automatically connect to the network, refer to the MegaFi 2 documentation at [www.airgain.com/products/megafi-2-hpue](http://www.airgain.com/products/megafi-2-hpue) or **scan the QR code**.



# 3

## Complete the Router Configuration

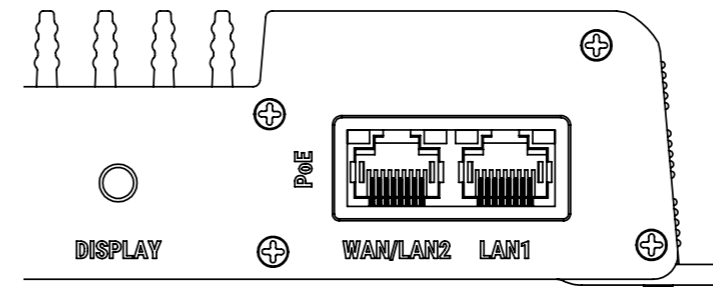

1. Connect your computer to the router **LAN1** port via Ethernet cable or using WiFi with the **SSID** name and password shown on the MegaFi 2 display or from the label underneath the router.
2. To configure your router settings through Mission Control, open your computer browser window, enter <https://192.168.113.1>, and accept any browser certificate warnings.
3. At the router's login screen, enter "**admin**" as username and the default password. The username and password are available on both the display and the label. Then click **Login**.
4. When the End User License Agreement appears, complete the information at the bottom of the form and click **Apply**.
5. You will then be directed to update your password. Please update the password and click **Save**.

**Note:** A factory reset restores the original default password.

# 4

## Cloud Connectivity

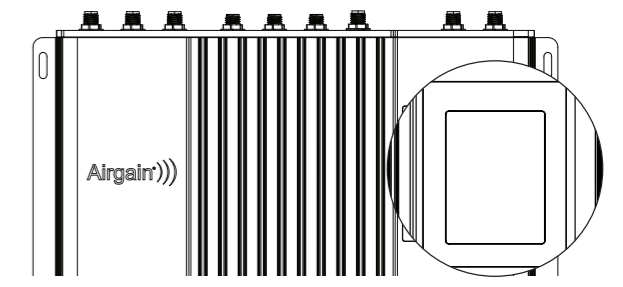

1. To connect to the cloud management environment, MegaPortal, open your computer browser window and enter <https://megaportal.airgain.net/>
2. If your organization already has an account, contact your organization's administrator to create a user account. If your organization does not yet have an account, contact [connectivity.support@airgain.com](mailto:connectivity.support@airgain.com) to create an administrative account for your organization. If you already have an account, enter the email and the password for your account and click **Sign in**.
3. To add a device as admin, click on **Devices** on the right-hand side of the screen, then click **New Device**. To add a device as a user, click on **New Device**. After clicking on **New Device**, enter the Serial Number and the MAC address from the display or from the label on the bottom of MegaFi 2 unit. Choose the desired pool or the default pool and click **Save**. You have now associated your device with your account and can now manage your MegaFi 2 from the cloud.
4. Update the device configuration from the cloud as needed for full deployment.